



# OWNER'S MANUAL

Version 3.2 | 22/11/2023  
738000X-MAN-EN

## CDL HIGH PERFORMANCE SAP LIFTING SYSTEM

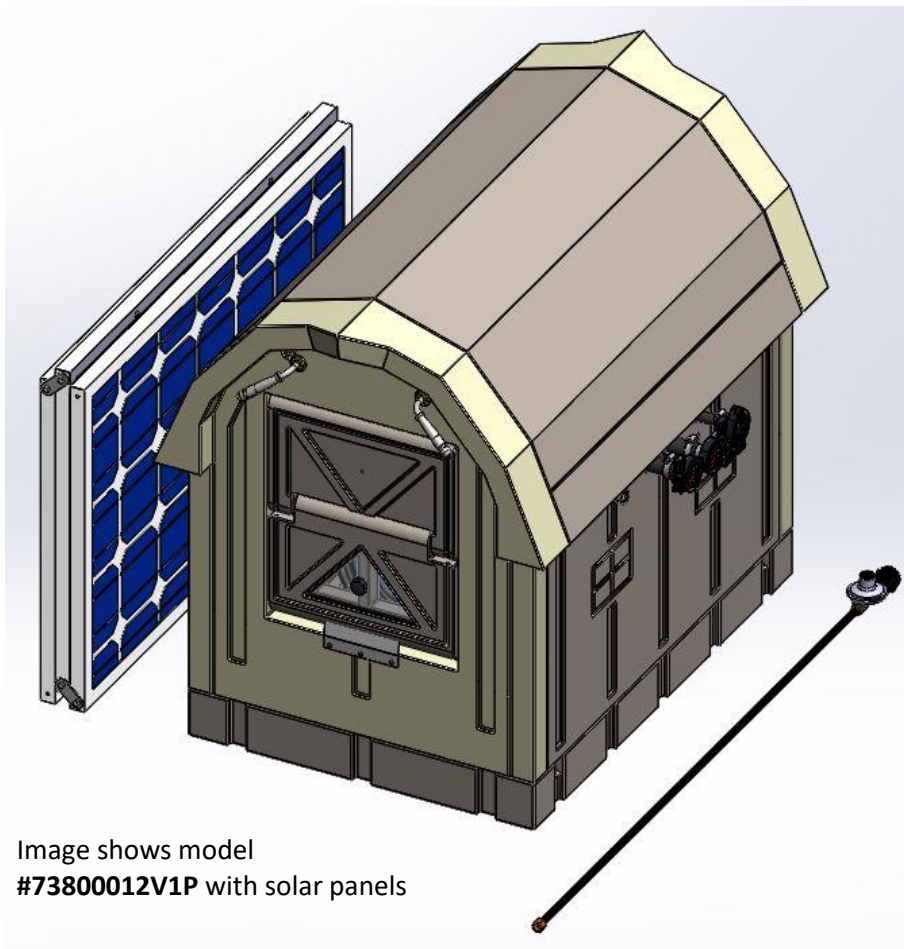

Image shows model  
**#73800012V1P** with solar panels

Models: 73800012V1P | 7380002301P | 7380002302P | 7380002302P-HP | 7380002301P-HP

# FINDING INFORMATION

Make a record for future use

Brand: \_\_\_\_\_

Purchase Date: \_\_\_\_\_

Model Number: \_\_\_\_\_

Serial Number: \_\_\_\_\_

Sales representative: \_\_\_\_\_

# TABLE OF CONTENTS

PRODUCT SPECIFICATIONS .....	5
MODEL PERFORMANCE CHART .....	9
INSTALLATION .....	12
USE AND OPERATION.....	20
Removing the front panel.....	20
Removing the tank from the shelter .....	21
How the submersible pump works .....	23
Manually running the pump using electricity .....	24
Shelter ventilation.....	25
Connecting the propane tank .....	26
Connecting the solar panels.....	29
MAINTENANCE .....	31
WARRANTY AND EXCLUSIONS.....	32

## INTRODUCTION

Thank you for choosing CDL's high vacuum sap lifter. Our years of experience serving maple syrup producers mean that we can guarantee effective, high-quality equipment. Before installing and using your equipment, make sure you have read and understood all of the instructions in this manual. If you have any problems upon receiving your equipment, please contact CDL or your local representative immediately.

## WARNING

It is very important to understand that CDL's sap lifter was created as an alternative to conventional sap lifters on the market. **However, CDL's sap lifters must only be used to pump sap upwards (Height depending on the model) along a line that uses gravity to pull the sap down a slope to a sap collection or pumping station. They are not designed for pumping water or transporting water over great distances.**

**Note: When moving the solar models, always remove the batteries from the shelter to prevent damage and facilitate transport.**

For 230 V models (**7380002301P, 7380002302P, 7380002302P-HP and 7380002301P-HP**), **it is very important to have the equipment wired by a qualified electrician**. Plan for 0.6–1 A of consumption for models 7380002301P, 7380002302P, 7380002302PHP. Model 7380002301P-HP provide a consumption between 5.6 and 6 amps on 230V).

The 12 V model (73800012V1P) **must be moved without the batteries in the shelter**. Further details can be found in the Installation section.

For the heating system, **always use an appropriate, certified propane tank**.

## PRODUCT SPECIFICATIONS

### Power supply

Solar model (73800012V1P): **12 V** powered by a series of two 6 V batteries, which are charged by a series of three tri-fold 100 W solar panels.

Electric models (7380002301P, 7380002302P, 7380002302P-HP and 7380002301P-HP): **230 V**

### Heating unit

Thermocouple protection against propane gas leakage if the pilot light goes out. The unit is fed by a 4-foot tube and comes with a regulator that fits on a standard propane tank.

### Pump

One or two 12 V submersible pumps, depending on the model.

### Shelter

Fully insulated plastic shelter. Bottom drain with a screen and quick access door. The front panel can be completely removed using two handles. Comes with two small, triangular ventilation hatches. The back of the shelter can be removed by unscrewing two wing nuts. This allows easy access to the batteries for solar and propane-heated models.

### Electrical box

For the solar model, the electrical box includes a button to manually operate the pump. For electric models (7380002301P,7380002302P,7380002302P-HP), the electrical box includes a button to manually run the pump as well as a transformer, which converts **240 V AC to 12 V DC**. **This is the transformer that the professional electrician will need to wire.** For the high pressure model (7380002301P-HP), the electrician will connect to the circuit breaker inside the box.

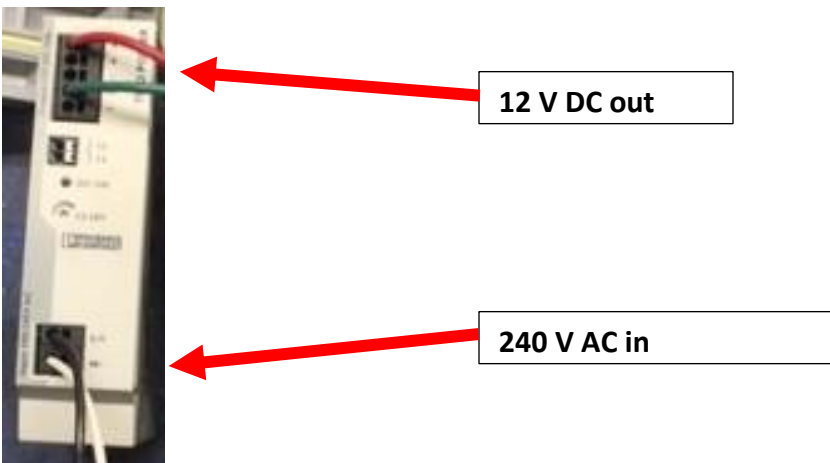

Recommended wire length for high pressure model 7380002301P-HP  
Recommended wire size to power the 240VAC high pressure model

Distance to travel (feet)	Wire size (AWG)	Wire Material	Loss of voltage	Amperage required (A)
0-250'	12	Copper	3%	5.6
0'-500'	10	Copper	3%	5.6
0'-750'	8	Copper	3%	5.6
0'-1 000'	6	Copper	3%	5.6
0'-1 250'	6	Copper	3%	5.6
0'- 1 500'	4	Copper	3%	5.6
0'-1 750'	4	Copper	3%	5.6
0'- 2 000'	4	Copper	3%	5.6
0-250'	8	Aluminium	3%	5.6
0'-500'	8	Aluminium	3%	5.6
0'-750'	6	Aluminium	3%	5.6
0'-1 000'	4	Aluminium	3%	5.6
0'-1 250'	4	Aluminium	3%	5.6
0'- 1 500'	3	Aluminium	3%	5.6
0'-1 750'	2	Aluminium	3%	5.6
0'- 2 000'	2	Aluminium	3%	5.6

### **Tank**

The tank is 12" in diameter and 18" long or 29" for the high pressure model only (7380002301P-HP). It has two covers that can be removed by manually opening the latches.

### **External connection**

1.5 gauge ferrules (1.5 gauge adapters for connecting to your system's lines not included). Consult the installation diagram below to see what is included. The connections are reversible; they can be connected on either side of the shelter.

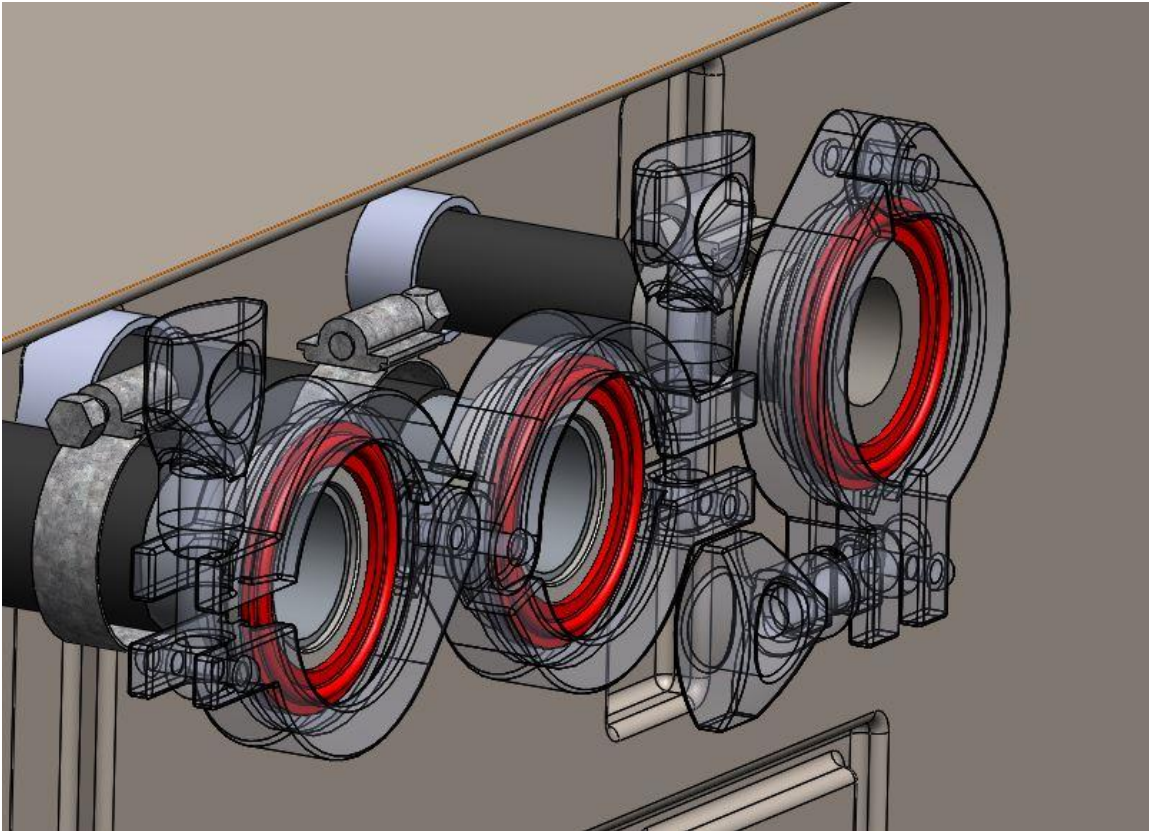

**Dimensions:**  
See diagram below.

### Dimensions de l'élévateur de sève CDL haut vacuum / CDL High Vacuum Sap lifter dimensions

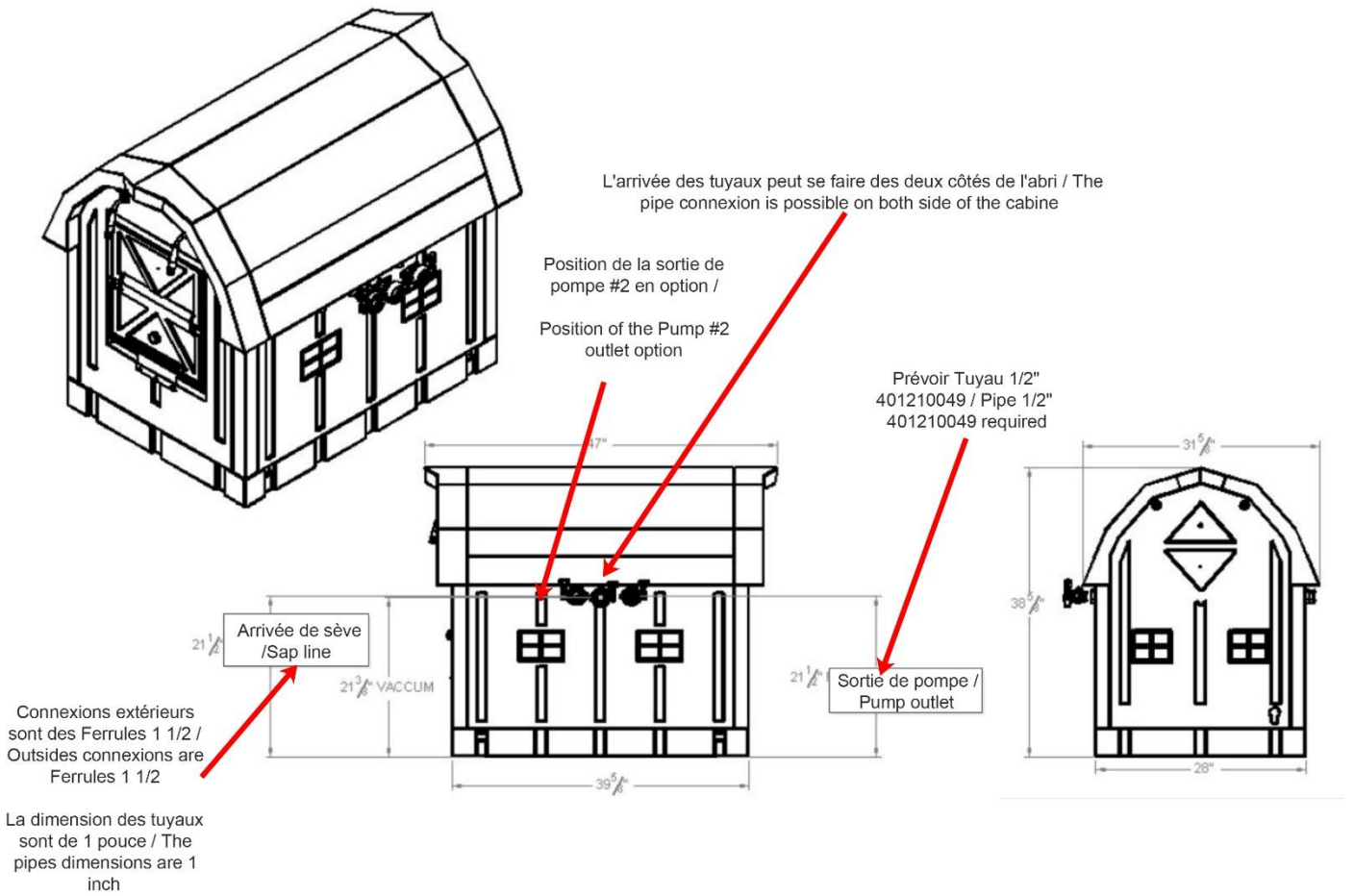



# MODEL PERFORMANCE CHART

Performance chart CDL high vacuum sap lifter kit 12V with solar pannel (one pump only) (73800012V1P)															
GPM and elevation feet	Vacuum level														
	29	28	27	26	25	24	23	22	21	20	19	18	17	16	15
GPM 5 feet of elevation	1.5	2	2.7	3	3.2	3.4	3.6	3.9	3.9	3.9	3.9	3.9	3.9	3.9	3.9
Maximum taps allowed	270	360	486	540	576	612	648	702	702	702	702	702	702	702	702
GPM 10 feet of elevation	1.3	1.9	2.2	2.5	2.7	3	3.2	3.3	3.3	3.3	3.3	3.3	3.3	3.3	3.3
Maximum taps allowed	234	342	396	450	486	540	576	594	594	594	594	594	594	594	594
GPM 15 feet of elevation	1.3	1.5	1.9	2.1	2.4	2.4	2.6	2.7	2.7	2.7	2.7	2.7	2.7	2.7	2.7
Maximum taps allowed	234	270	342	378	432	432	468	486	486	486	486	486	486	486	486
GPM 20 feet of elevation	1.1	1.4	1.7	1.8	2	2.1	2.1	2.1	2.1	2.1	2.1	2.1	2.1	2.1	2.1
Maximum taps allowed	198	252	306	324	360	378	378	378	378	378	378	378	378	378	378

Maximum elevation allowed is 20 feet

Performance chart CDL high vacuum sap lifter kit 230V (one pump option) (738000230V1P)															
GPM and elevation feet	Vacuum level														
	29	28	27	26	25	24	23	22	21	20	19	18	17	16	15
GPM 5 feet of elevation	2.1	2.9	3.9	4.3	4.6	4.9	5.1	5.6	5.6	5.6	5.6	5.6	5.6	5.6	5.6
Maximum taps allowed	385	514	694	771	822	874	925	1002	1002	1002	1002	1002	1002	1002	1002
GPM 10 feet of elevation	1.9	2.7	3.1	3.6	3.9	4.3	4.6	4.7	4.7	4.7	4.7	4.7	4.7	4.7	4.7
Maximum taps allowed	334	488	565	642	694	771	822	848	848	848	848	848	848	848	848
GPM 15 feet of elevation	1.9	2.1	2.7	3	3.4	3.4	3.7	3.9	3.9	3.9	3.9	3.9	3.9	3.9	3.9
Maximum taps allowed	334	385	488	540	617	617	668	694	694	694	694	694	694	694	694
GPM 20 feet of elevation	1.6	2	2.4	2.6	2.9	3	3	3	3	3	3	3	3	3	3
Maximum taps allowed	282	360	437	462	514	540	540	540	540	540	540	540	540	540	540

Maximum elevation allowed is 20 feet

Performance chart CDL high vacuum sap lifter kit 230V (two pumps option) (738000230V2P)

GPM and elevation feet	Vacuum level														
	29	28	27	26	25	24	23	22	21	20	19	18	17	16	15
GPM 5 feet of elevation	4.2	5.8	7.8	8.6	9.2	9.8	10.2	11.2	11.2	11.2	11.2	11.2	11.2	11.2	11.2
Maximum taps allowed	770	1028	1338	1542	1644	1748	1850	2004	2004	2004	2004	2004	2004	2004	2004
GPM 10 feet of elevation	3.8	5.4	6.2	7.2	7.8	8.6	9.2	9.4	9.4	9.4	9.4	9.4	9.4	9.4	9.4
Maximum taps allowed	668	976	1130	1284	1388	1542	1644	1696	1696	1696	1696	1696	1696	1696	1696
GPM 15 feet of elevation	3.8	4.2	5.4	6	6.8	6.8	7.4	7.8	7.8	7.8	7.8	7.8	7.8	7.8	7.8
Maximum taps allowed	668	770	976	1080	1234	1234	1336	1388	1388	1388	1388	1388	1388	1388	1388
GPM 20 feet of elevation	3.2	4	4.8	5.2	5.8	6	6	6	6	6	6	6	6	6	6
Maximum taps allowed	564	720	874	924	1028	1080	1080	1080	1080	1080	1080	1080	1080	1080	1080

Maximum elevation allowed is 20 feet \*\*\*Warning : Each pump need is own pipe outlet (Cannot work together on the same pipe) See the installation instructions

Performance chart CDL high vacuum sap lifter kit 230V (two pumps option in serie) (7380002302P-HP)

GPM and elevation feet	Vacuum level														
	29	28	27	26	25	24	23	22	21	20	19	18	17	16	15
GPM 5 feet of elevation	1.6	2	2.7	3.1	3.7	4	4.2	4.4	4.5	4.6	4.8	4.8	4.8	4.8	4.8
Maximum taps allowed	288	360	486	558	666	720	756	792	810	828	864	864	864	864	864
GPM 10 feet of elevation	1.6	2	2.7	3.1	3.7	4	4.2	4.4	4.5	4.3	4.5	4.5	4.5	4.5	4.5
Maximum taps allowed	288	360	486	558	666	720	756	792	810	774	810	810	810	810	810
GPM 15 feet of elevation	1.6	2	2.7	3.1	3.4	3.5	3.7	3.7	3.7	3.8	3.9	3.9	3.9	3.9	3.9
Maximum taps allowed	288	360	486	558	612	630	666	666	666	684	702	702	702	702	702
GPM 20 feet of elevation	1.6	1.9	2.6	3	3	3.2	3.2	3.3	3.3	3.3	3.4	3.4	3.4	3.4	3.4
Maximum taps allowed	288	342	468	540	540	576	576	594	594	594	612	612	612	612	612
GPM 25 feet of elevation	1.6	1.9	2.5	2.8	3	3.1	3.2	3.3	3.3	3.3	3.4	3.4	3.4	3.4	3.4
Maximum taps allowed	288	342	450	504	540	558	576	594	594	594	612	612	612	612	612
GPM 30 feet of elevation	1.6	1.9	2.5	2.8	3	3.1	3.2	3.3	3.3	3.3	3.4	3.4	3.4	3.4	3.4
Maximum taps allowed	288	342	450	504	540	558	576	594	594	594	612	612	612	612	612
GPM 33 feet of elevation	1.5	1.8	2.4	2.7	2.9	3	3.1	3.2	3.2	3.2	3.3	3.3	3.3	3.3	3.3
Maximum taps allowed	270	324	432	486	522	540	558	576	576	576	594	594	594	594	594

Maximum elevation allowed is 33 feet

**Performance charter for large capacity high vacuum sap elevator  
CDL 230V with 0.5 HP 230V pump  
(7380002301P-HP)**

GPM and elevation in feet	Vacuum Level														
	29	28	27	26	25	24	23	22	21	20	19	18	17	16	15
GPM 5 feet elevation	6	12.3	13	14.2	14.5	15.2	15.4	15.5	15.6	15.7	15.7	15.7	15.7	15.7	15.7
equivalent in taps	1080	2214	2340	2556	2610	2736	2772	2790	2808	2826	2826	2826	2826	2826	2826
GPM 10 feet elevation	6	12.3	13	14.1	14.5	15	15.2	15.3	15.4	15.5	15.5	15.5	15.5	15.5	15.5
equivalent in taps	1080	2214	2340	2538	2610	2700	2736	2754	2772	2790	2790	2790	2790	2790	2790
GPM 15 feet elevation	6	12.2	12.9	14	14.4	14.8	14.9	15	15.1	15.2	15.2	15.3	15.3	15.3	15.3
equivalent in taps	1080	2196	2322	2520	2592	2664	2682	2700	2718	2736	2736	2754	2754	2754	2754
GPM 20 feet elevation	6	12.1	12.8	13.9	14.3	14.5	14.6	14.8	14.8	15	15	15	15.1	15.1	15.1
equivalent in taps	1080	2178	2304	2502	2574	2610	2628	2664	2664	2700	2700	2700	2718	2718	2718
GPM 25 feet elevation	6	12.1	12.7	13.8	14.2	14.3	14.4	14.6	14.6	14.8	14.8	14.8	14.9	14.9	14.9
equivalent in taps	1080	2178	2286	2484	2556	2574	2592	2628	2628	2664	2664	2664	2682	2682	2682
GPM 30 feet elevation	5.9	11.9	12.5	13.4	13.9	14	14.1	14.3	14.3	14.4	14.4	14.4	14.5	14.5	14.5
equivalent in taps	1062	2142	2250	2412	2502	2520	2538	2574	2574	2592	2592	2592	2610	2610	2610
GPM 35 feet elevation	5.8	11.7	12.3	13.1	13.6	13.7	13.8	13.9	14	14	14.1	14.1	14.2	14.2	14.2
equivalent in taps	1044	2106	2214	2358	2448	2466	2484	2502	2520	2520	2538	2538	2556	2556	2556
GPM 40 feet elevation	5.7	11.6	12.2	12.7	13.3	13.3	13.4	13.5	13.6	13.6	13.7	13.7	13.8	13.8	13.8
equivalent in taps	1026	2088	2196	2286	2394	2394	2412	2430	2448	2448	2466	2466	2484	2484	2484
GPM 45 feet elevation	5.6	11.4	12	12.3	13	13	13.1	13.2	13.3	13.3	13.4	13.4	13.5	13.5	13.5
equivalent in taps	1008	2052	2160	2214	2340	2340	2358	2376	2394	2394	2412	2412	2430	2430	2430
GPM 50 feet elevation	5.5	11.2	11.8	12	12.7	12.7	12.8	13	13	13	13.1	13.1	13.1	13.1	13.1
equivalent in taps	990	2016	2124	2160	2286	2286	2304	2340	2340	2340	2358	2358	2358	2358	2358

50' is the maximum elevation. The length of the pipe must be 100' long maximum. Refer to the installation diagram.

# INSTALLATION

**Important:** Refer to the appropriate installation diagram below.

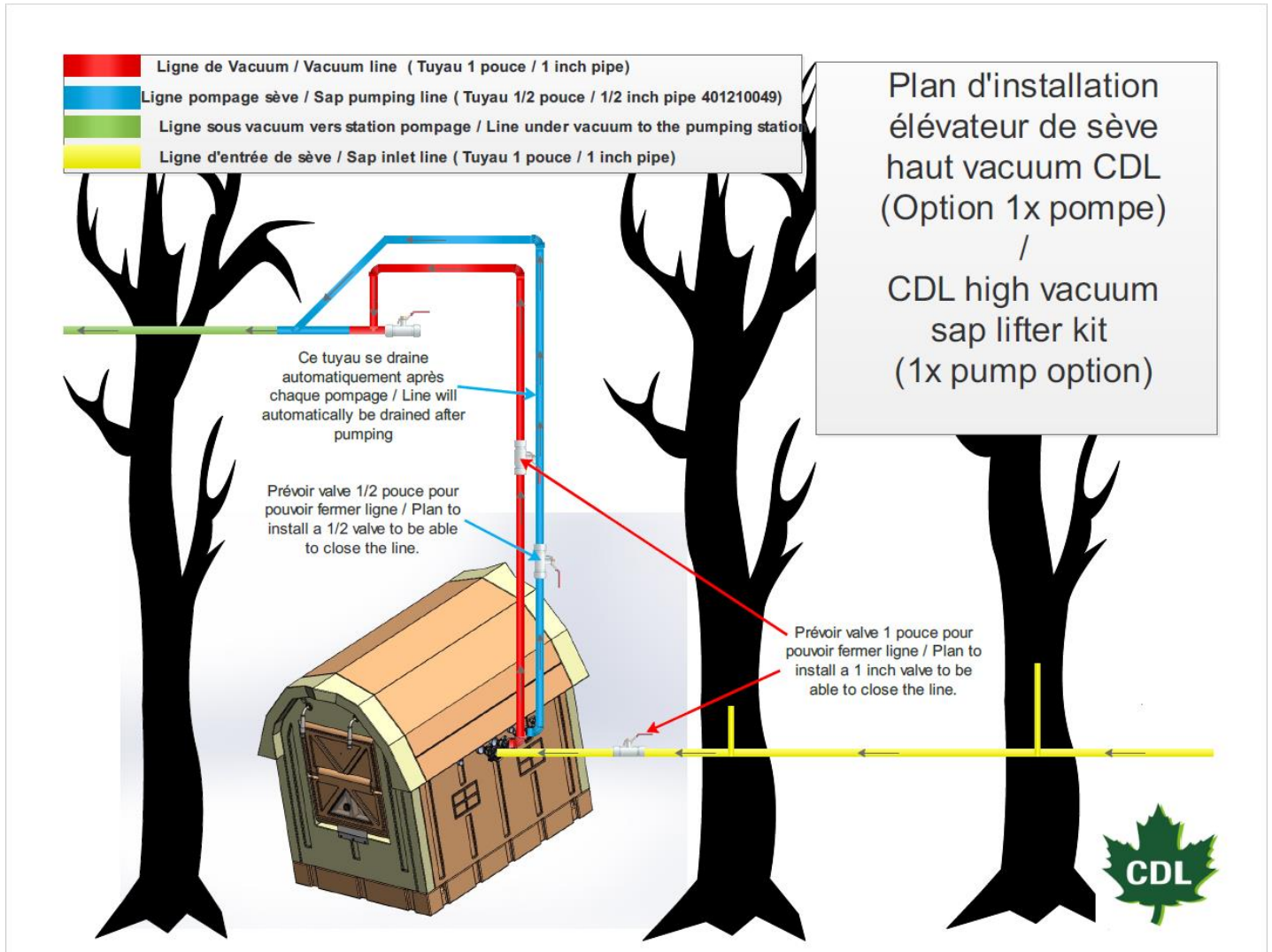

- Ligne de Vacuum / Vacuum line ( Tuyau 1 pouce / 1 inch pipe)
- Ligne pompage sève #1 / Sap pumping line #1 ( Tuyau 1/2 pouce / 1/2 inch pipe 401210049)
- Ligne sous vacuum vers station pompage / Line under vacuum to the pumping station
- Ligne d'entrée de sève / Sap inlet line ( Tuyau 1 pouce / 1 inch pipe)
- Ligne pompage sève #2 / Sap pumping line #2 ( Tuyau 1/2 pouce / 1/2 inch pipe 401210049)

Plan d'installation  
 élévateur de sève  
 haut vacuum CDL  
 (Option 2x pompe)  
 /  
 CDL high vacuum  
 sap lifter kit  
 (2x pump option)

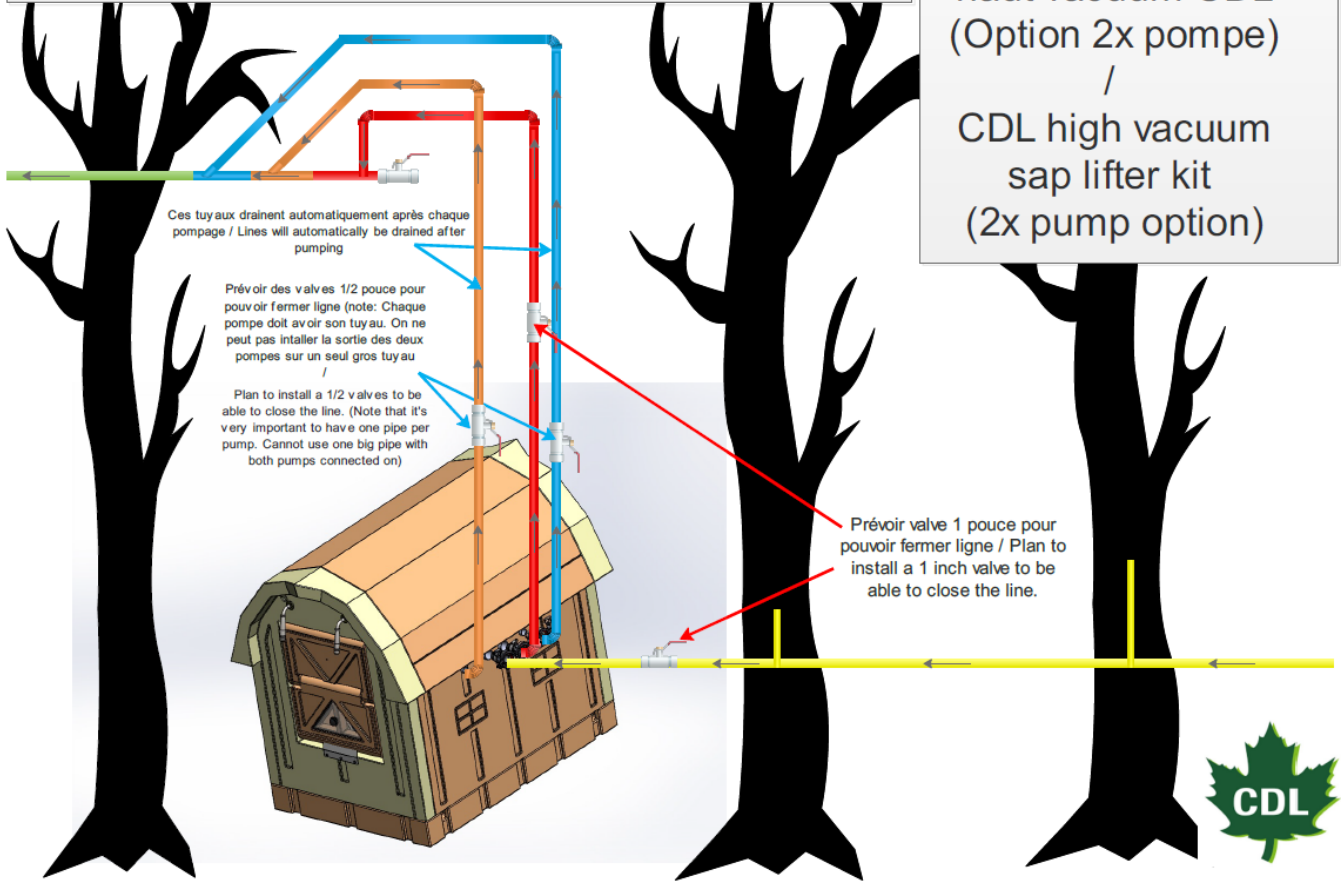

- Ligne de Vacuum / Vacuum line ( Tuyau 1 pouce / 1 inch pipe)
- Ligne pompage sève / Sap pumping line ( Tuyau 1/2 pouce / 1/2 inch pipe 401210049)
- Ligne sous vacuum vers station pompage / Line under vacuum to the pumping station
- Ligne d'entrée de sève / Sap inlet line ( Tuyau 1 pouce / 1 inch pipe)

Plan d'installation élévateur de sève haut vacuum CDL seulement pour modèle: (7380002301P-HP) / Installation guide only for CDL high vacuum sap lifter for model: (7380002301P-HP)

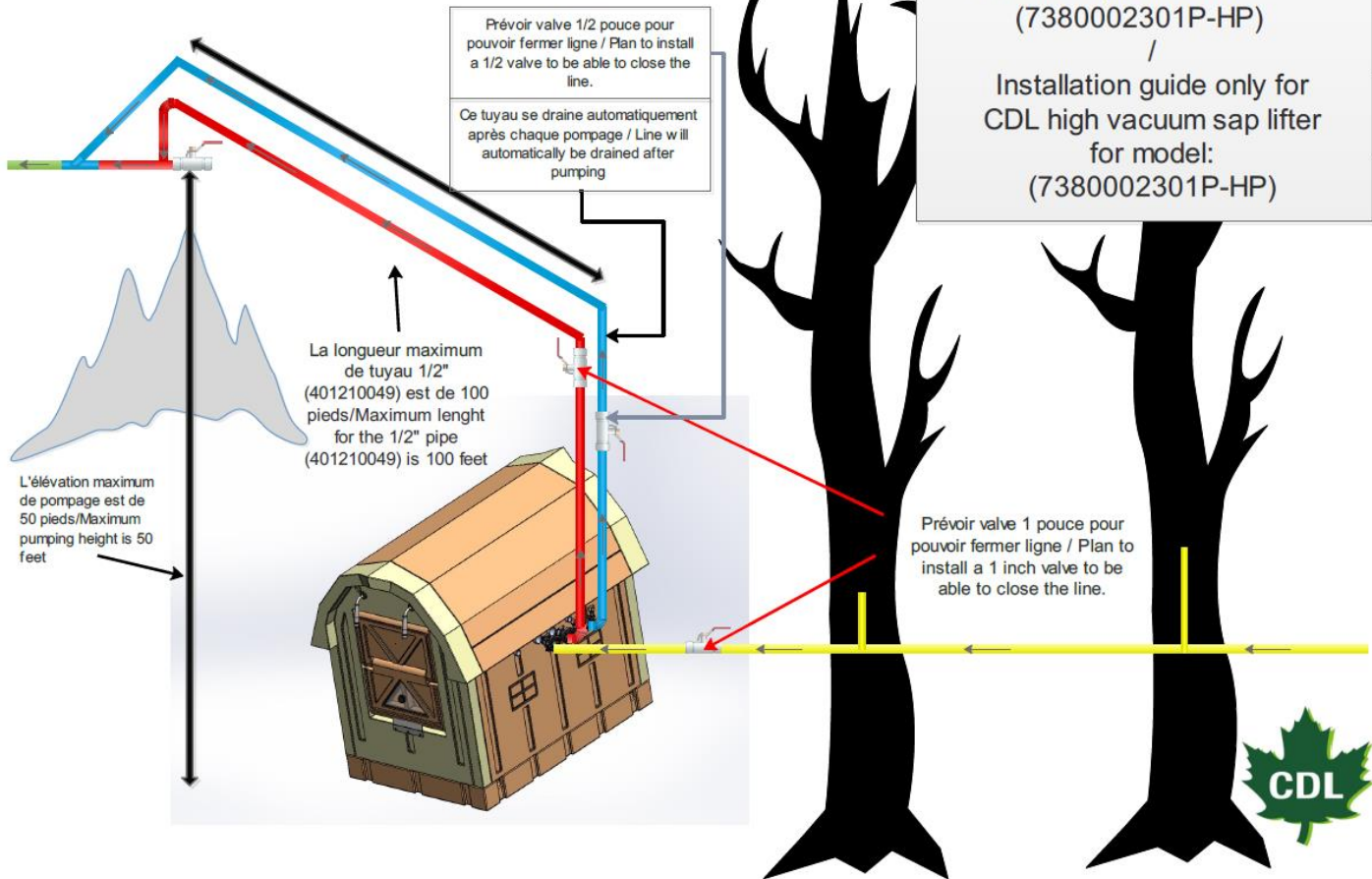

**Step 1:**

Build a base in your stand. Choose a location that will allow you to install the solar panels as close to the shelter as possible. In order to simplify the construction of the shelter, please check its dimensions in the **Product Specifications** section. Pay attention to the height of your inlet lines. An option is available for those who do not wish to build their support. CDL offers a height-adjustable support designed for this purpose (item #738120).

**Adjustable height  
support # 738120**

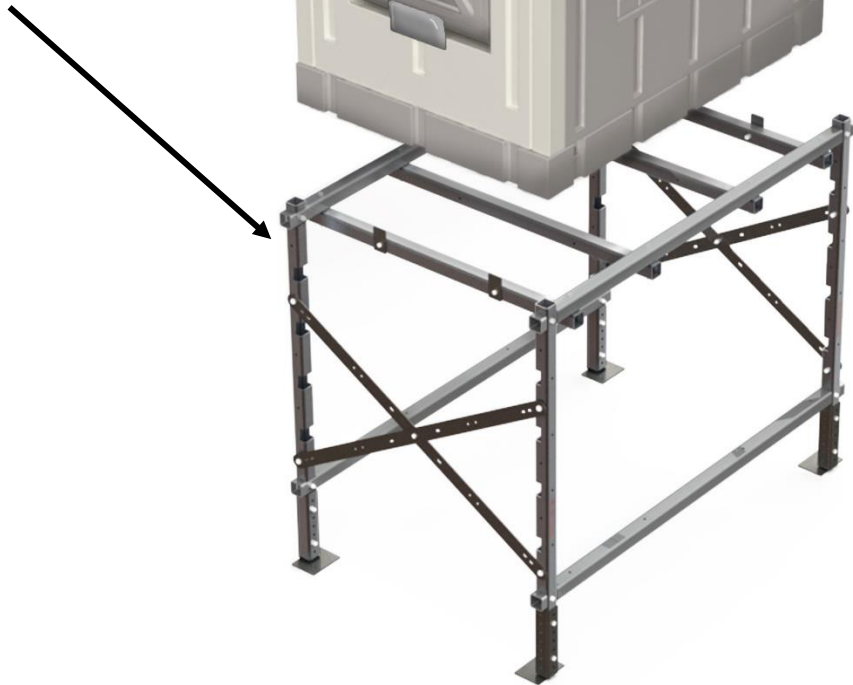

**Step 2:**

Place the shelter on the base, making sure that the lines are connected according to the diagrams below. **(Note: Do not install a non-return valve, as this will prevent the system from working properly. The line[s] must automatically drain back into the tank in the shelter to prevent freezing.)** Do exactly as the diagram indicates. The holes have been designed so that the lines can be connected on either side of the shelter.

**Step 3:**

If you have a solar model, install the solar panels vertically on a tree or similar so that they receive as much sunlight as possible and can connect to the system. Continue to step 4. **If you have an electric model, all you need to do is have a certified electrician connect a 230 V power supply and you will be finished installation.**

**Step 4:**

Unscrew the wing nuts in the upper rear part of the shelter.

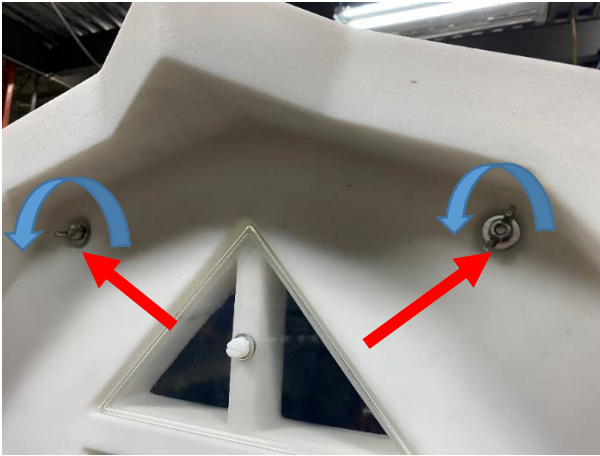



**Step 5:**  
Remove the shelter's back panel.



**Step 6:**  
Place both batteries on their base.

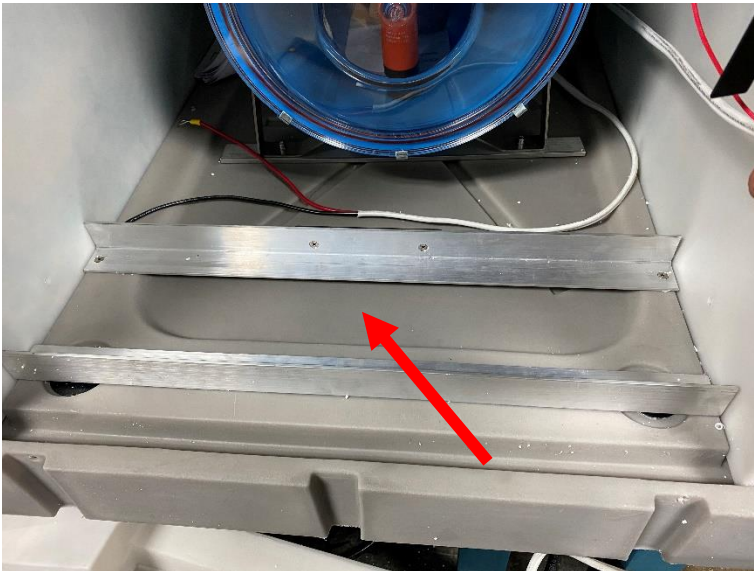

**Step 7:**

Using the bolts, secure the wire that connects the two batteries.

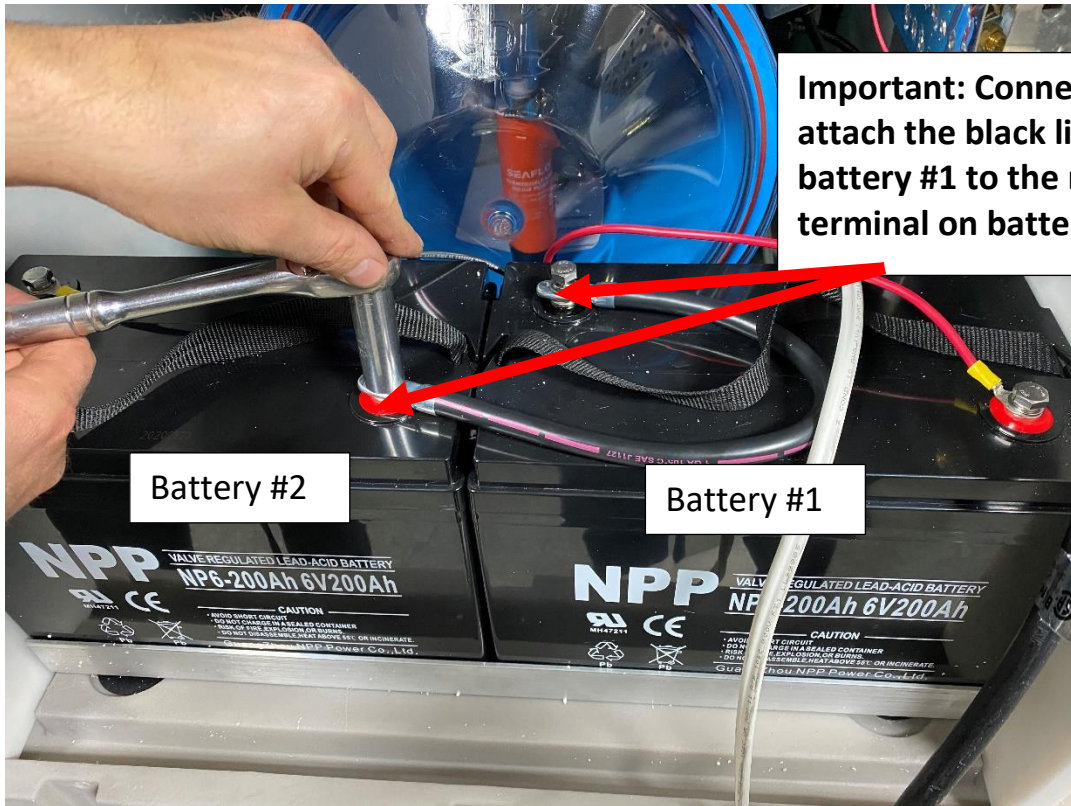

**Important: Connect and attach the black line of battery #1 to the red terminal on battery #2.**

Battery #2

Battery #1

**Step 8:**

Using the bolts, secure the wires to power the system.

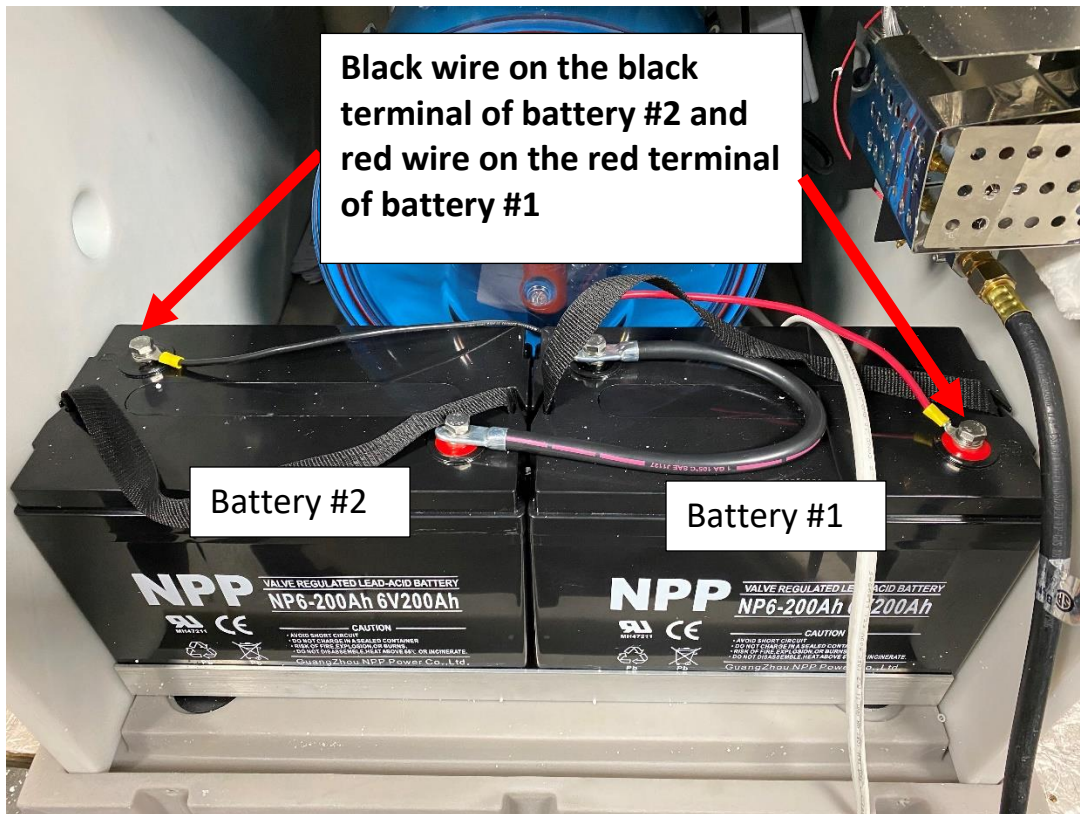

**Step 9:**

Replace the rear panel of the shelter.

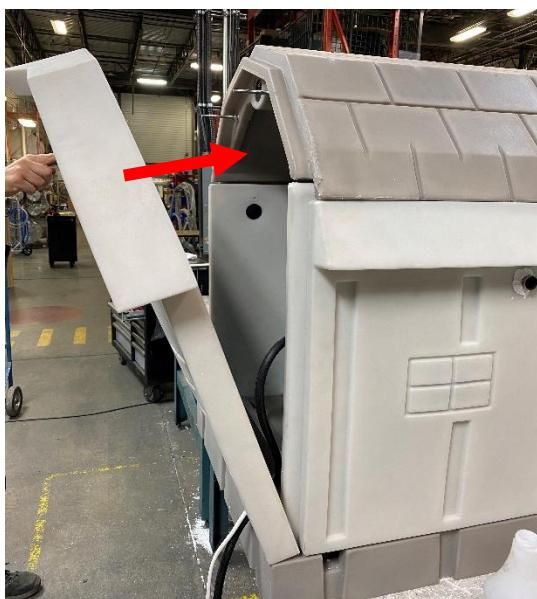

## USE AND OPERATION

### Removing the front panel

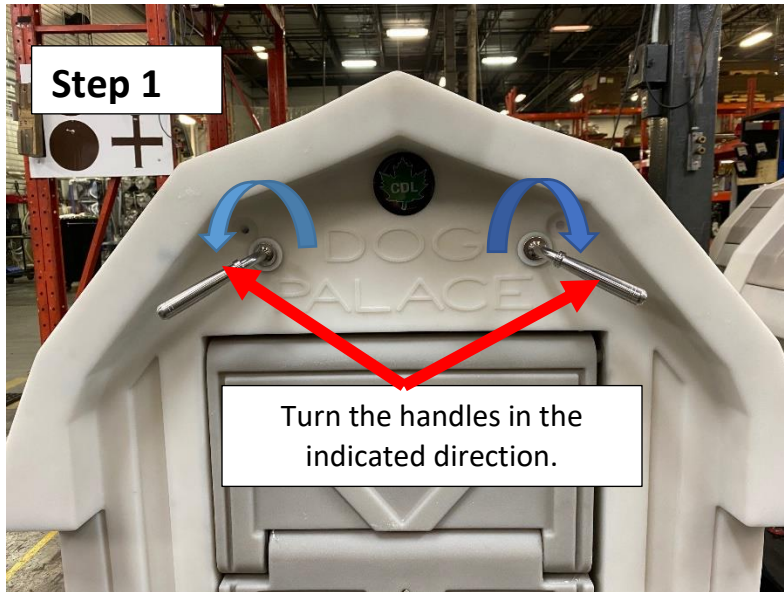



**Step 3**

Pull the panel out as shown.

### Removing the tank from the shelter

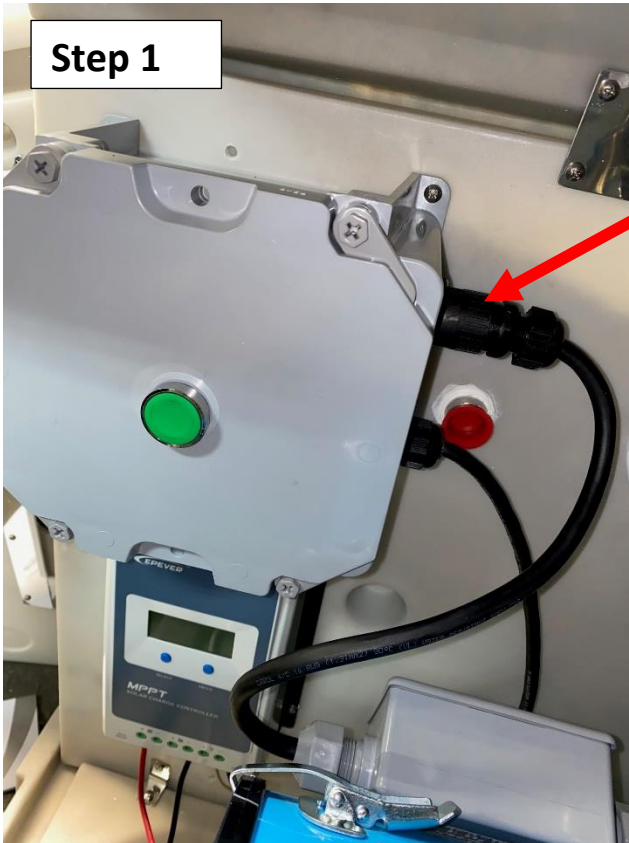

**Step 1**

Turn the nut on the electrical connector counterclockwise, then pull it out of the socket.

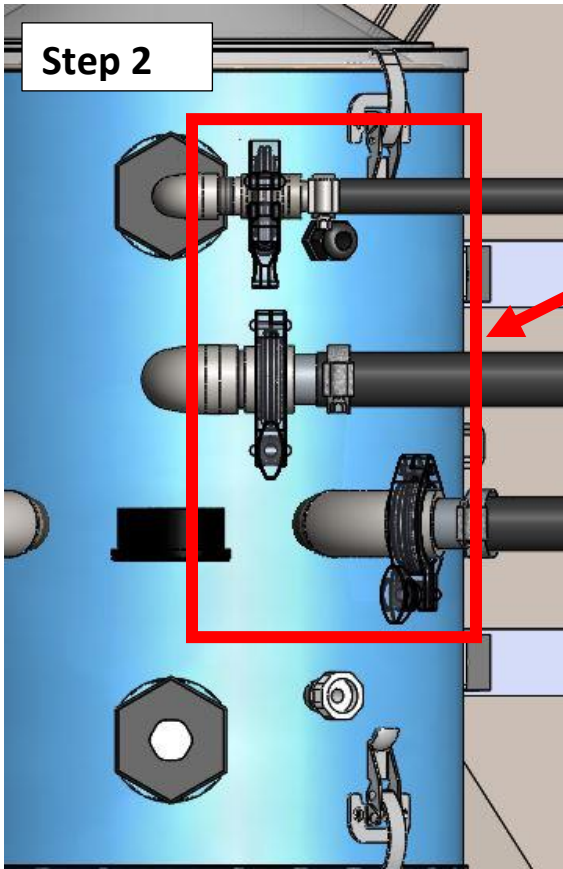

Unscrew and remove the quick-release fasteners, taking care not to lose the silicone gaskets.

**Important: You must replace the silicone gaskets when reconnecting.**

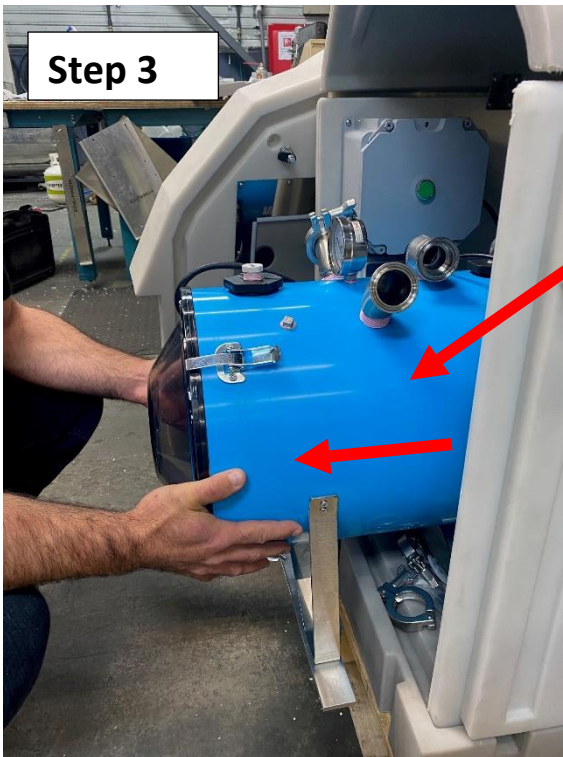

Remove the tank as shown.

## How the submersible pump works

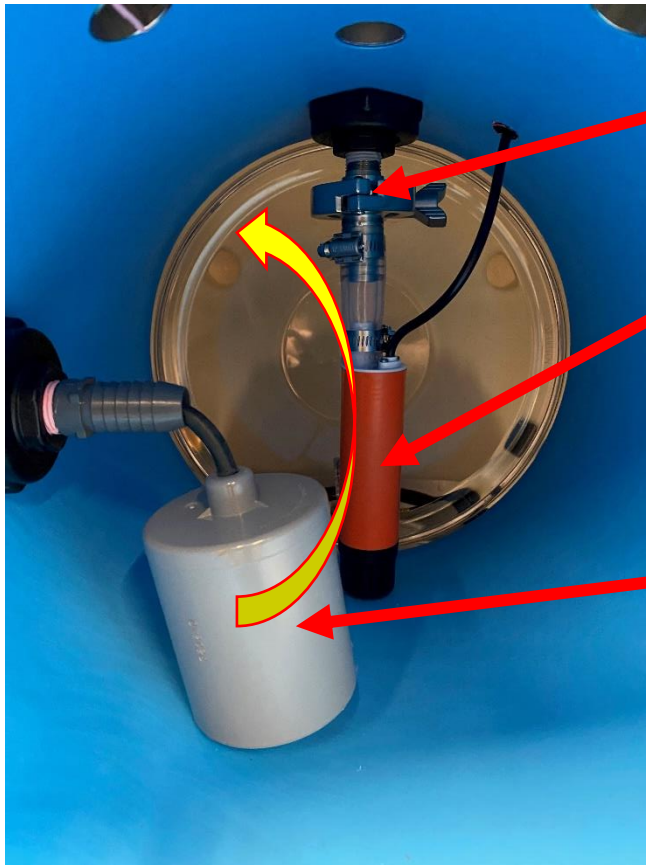

Pump quick-release fasteners

12 V submersible pump

When the float reaches the right level, it will automatically start the submersible pump.

At the beginning of the season, and periodically throughout the season, make sure the float and pump are working correctly by lifting the float with your hand.

## Manually running the pump using electricity

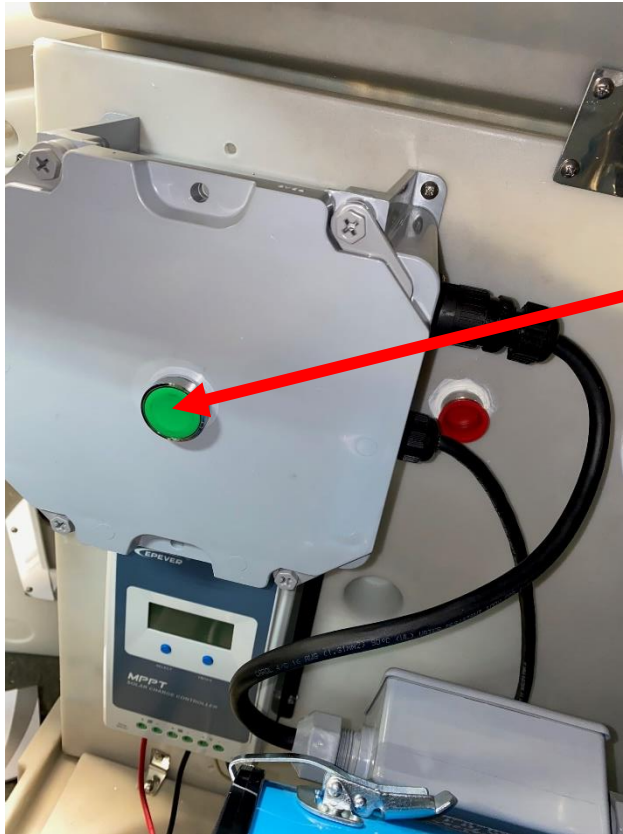

Press and hold the button.

When you release the button, the pump will automatically shut off.



## Shelter ventilation



The ventilation is preset at the factory. If you want to change the amount of ventilation, you will need to add or remove washers to increase or decrease the opening.

**Good ventilation is very important for the propane heating system (pilot light)!**

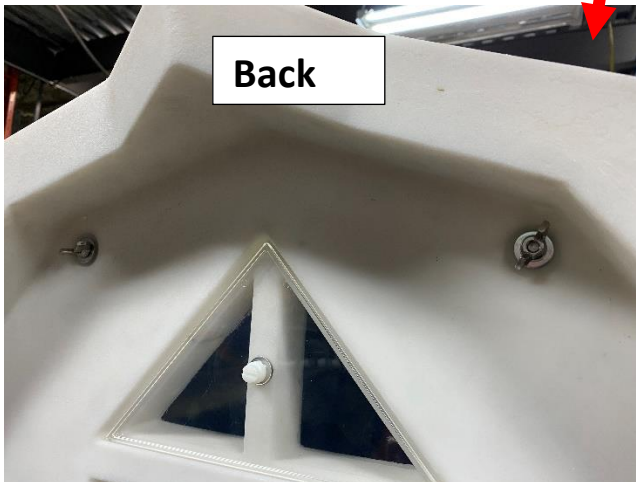

## Connecting the propane tank

**ATTENTION! Make sure your tank is compliant and safe.**



Check for damage to the regulator and tubing.

The inside and outside of the regulator nut must be clean.

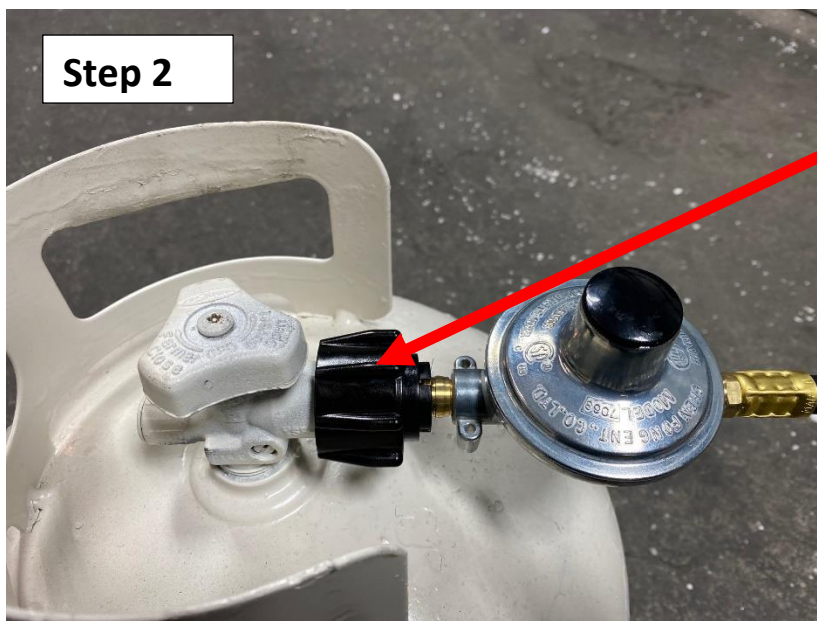

Screw the regulator into your propane tank.

Make sure it's tightened properly to prevent leaks.

**Very important! Make sure that there are no gas leaks before lighting the pilot light.**

Operating the propane heater (with pilot light):

1. **STOP!** Read the safety instructions.
2. Read all alerts and safety instructions in the manual.
3. Find the valve on the side of the unit, gently press the gas control knob (DO NOT FORCE IT), and turn it clockwise to the OFF position (see Figure 1).

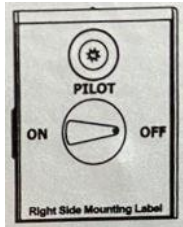

**Figure 1**

4. Wait 5 minutes to make sure all gas has been cleared. If you smell gas: **STOP!** Do not turn on the pilot light or activate any electrical equipment. If there is no smell, proceed to the next step.
5. Push the control knob lightly and turn it counter clockwise to the PILOT position (see Figure 2).



**Figure 2**

- You can see the pilot light behind the burner on the valve side (see Figure 3).



**Figure 3**

Flame

Do not attempt to light the pilot light manually.

6. Press and hold the control knob firmly.
7. With the control knob held down, repeatedly press the ignition button until the pilot light starts.
8. Keep the control knob pressed for 30 seconds after the pilot light has been ignited.

Then release the control knob.

- If the knob does not come up after you release it, stop and call a certified technician immediately.
- If the pilot light does not stay on after several attempts, turn the control knob to the OFF position and call a certified technician.

## Connecting the solar panels

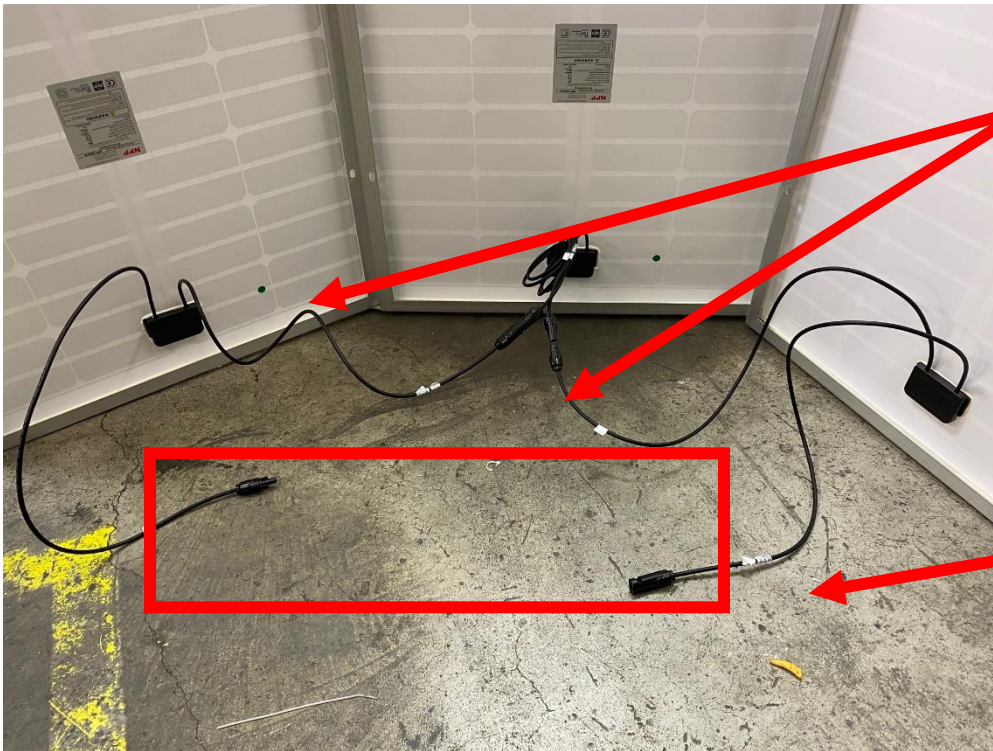

The panels must be connected together (in series) like this.



























These connectors must be connected to the designated connectors in the shelter.

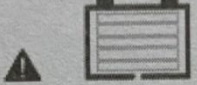

Two shelter connectors for the solar panels

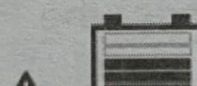
**Note: Install the solar panels vertically and facing a direction that lets them receive as much light as possible during the day (usually South). Do not place them beneath a tree or in a shaded corner.**

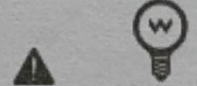
Controller information (solar model only)

Icon		 Day mode
	 Night mode	
	 Not charging. <b>Charging is done automatically by the controller.</b>	
	 Charging. <b>Charging is done automatically by the controller.</b>	
PV	 Solar panel voltage and temperature	
	 Battery level	
BATT.	 Battery voltage and temperature	
BATT. TYPE	 Battery type	
	 Not used	
	 Not used	
LOAD	 Energy consumption	
Icon		
	 Warning: Battery completely drained	
	 Warning: Battery voltage too high	
	 Warning: Battery temperature too high	
	 Not used	

## MAINTENANCE

- Clean the tank and pump regularly throughout the season.
- Regularly check the propane gas connections for leaks.
- Make sure your propane tank is kept full.
- Clean the solar panels if they become dirty.
- Regularly check that the system is working properly by watching it run or using the manual start button.
- The system can remain electrically powered all year; however, for the solar model, it is strongly recommended to unplug the batteries in the off-season and connect them to a charger that can maintain their charge.
- For electrical models, turn off the power in the off-season.
- Make sure the lines, including the line down to the pumping station, have a good slope for drainage.
- Make sure that the drain screen is in place to prevent small rodents from getting in.
- During the off-season, disconnect the propane tank and protect the regulator from water, dirt, and the sun as much as possible.
- Frequently verify that the propane network is leak free.
- In the off season, make sure all the pumps are drained and cleaned to prevent freezing in the winter.
- In the off season, shutdown the 230V power source.
- In the off season, make sure the solar charging system remains active to maintain the charge in the batteries.

## WARRANTY AND EXCLUSIONS

Your sap lifter is covered by a 1-year limited warranty. For one year from the date of original purchase, CDL Sugaring Equipment Inc. (CDL) will repair or replace parts of this system that are defective in material or workmanship provided that it is installed, operated, and maintained according to the instructions provided in the user manual.

### Exclusions

**This warranty does not cover the following:**

1. Products whose original serial number has been removed or modified or is not easily readable.
2. Equipment that has changed ownership or is located outside of North America.
3. Breakage caused by below-freezing temperatures inside the shelter.
4. Failure to follow CDL's maintenance procedure.
5. Systems that have been started dry (no liquid inside).
6. Production losses caused by problems with the sap lifter.
7. Loss of income caused by the quality of the syrup.
8. Service calls that do not involve malfunctions, manufacturing or material defects, or products that were not used according to the provided instructions.
9. Service calls to check installation or receive instruction on using the sap lifter.
10. Service calls after one year.
11. Damage caused by: repairs made by unauthorized technicians; use of parts other than original CDL parts or parts that were not obtained from an authorized technician; or external causes like abuse, misuse, accidents, fires, or natural disasters.
12. Damage caused by misuse, negligence, modifications made by the customer, or electrical problems.
13. Damage caused by the use of products not intended for use in the sap lifter or misuse of cleaning products.
14. The solar panel system is only covered by the manufacturer warranty.



## **Disclaimer of implied warranties; Limitation of remedies**

The customer's sole remedy under this limited warranty is the repair or replacement of the product as described above. Claims based on implied warranties, including implied warranties of merchantability or fitness for a particular purpose, are limited to one year or the shortest period permitted by law, which shall not be less than one year. CDL Maple Sugaring Equipment Inc. shall not be held responsible for incidental or indirect damages or for material and implicit damages. Some states and provinces do not allow limitations or exemptions on incidental or indirect damages or limitations on implied warranties. In this case, these restrictions or exemptions may not apply. This written warranty gives you specific legal rights. Depending on the state or province, you may have other rights.

## **If you need to call the repair service**

Keep your receipt, delivery note, or other valid proof of payment to establish the warranty period in case you need to call for repairs. If a repair is made, it is in your best interest to obtain and keep all receipts. The service to which you are entitled under this warranty must be obtained by contacting CDL at the address or telephone number below. Your high vacuum sap lifter will be serviced by CDL in Canada. Any features and specifications described or illustrated are subject to change without notice.

CDL Sugaring Equipment Inc  
257 route 279  
Saint-Lazare-de-Bellechasse, QC G0R 3J0  
Canada

418-883-5158 | 1-800-361-5158  
cdlinc.ca

CDL USA  
3 Lemnah Drive  
St. Albans VT 05478  
United States

802-527-0000 | 1-800-762-5587  
cdlusa.com